

Master of Pipe Profiling

Pipe Profile Cutting Machine

PIPE COASTER



MARUHIDE KOKI CO., LTD.

Manufacture and Distribution of PIPE COASTER Pipe Profile Cutting Machine

15-33, Kitasuna 2-Chome, Koto-ku, Tokyo, Japan 136-0073

TEL : +81-3-3644-1256 FAX : +81-3-3644-9650 Mail : info@maruhide.co.jp

●Website : <http://www.maruhide.co.jp/en/>

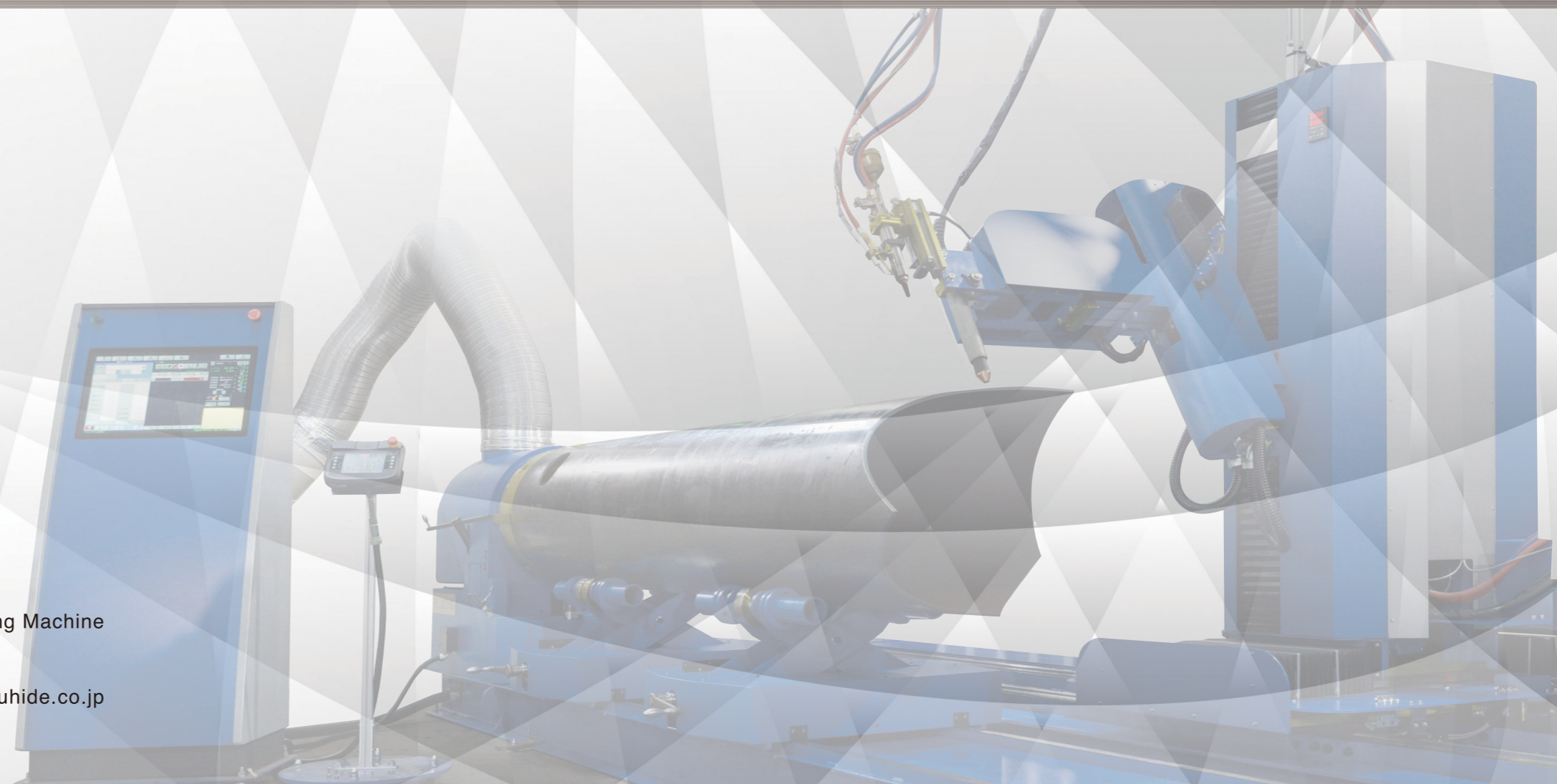

PIPE COASTER MA Series "Japanese No.1 Pipe Profiler"

New!! Speed Up!! 2 times faster!!

※ In our company's comparison



PIPE COASTER MA Series

Cutting shapes



Highlight functions of MA Series

Amazing visibility!
Interactive operation panel

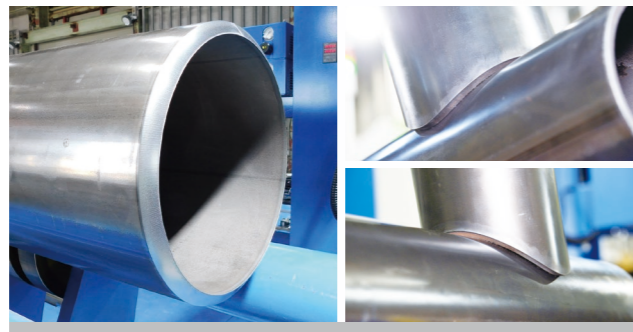

Magnificent cutting surface
made with highly rigid machine body!

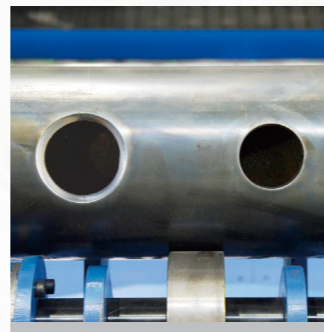

Various hole cuts



Torch block
made high precision and quick movements possible!

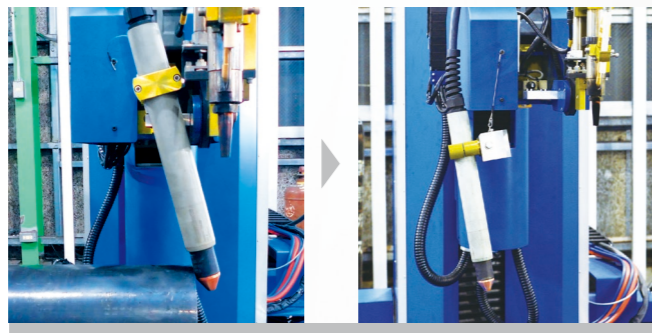

Magnetic torch protection
[Break-away torch system]

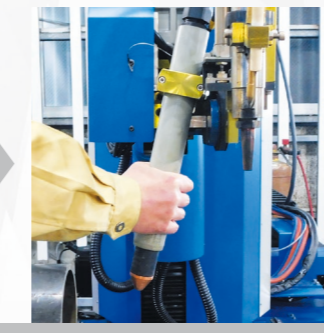

Maintenance-free!
Prevent torch damage!

MA Series Mechanical Specifications

Specifications / Model		400MA	650MA	1000MA	1350MA	1500MA
Cutting pipe diameter	(mm)	34 to 406.4	60.5 to 660.4	76.3 to 1016	165.2 to 1371.6	267.4 to 1524
	(inches)	1-3/8 to 16	2 to 26	3 to 40	6 to 54	10 to 60
Axis numbers (model)		5 axis (MA5) / 6 axis (MA6) / 7 axis (MA7)				
Interactive cutting software (PIPE STUDIO)		Standard				
Interactive operation panel / Remote control panel		Standard				
Windows network		Standard				
Torch travel length (mm)		1000 / 3000 / 6000 / 9000 / 12000 / 15000 / 18000				
Pipe trolley numbers		Torch rail 1000 to 3000 mm x 2 sets / 6000 to 9000 mm x 3 sets / 12000 mm or more x 5 sets				
Self-centering pipe chuck		400MA, 650MA, 1000MA	4 or 5 jaws / 1350MA, 1500MA		3 jaws	
Laser sensing system		Standard				
Plasma cutting machine		Standard				
Oxy/fuel cutting		Option				
Manual pre-heating unit		Option				
Auto pre-heating system		Option				
Motorized clamping system (chuck)		Option				
Motorized traveling system (pipe trolley)		Option				
Touch sensor (side)		Option				
Auto marking system (powder)		Option				
Auto marking system (inkjet)		Option				
Cutting system for rear side of chuck		Option				
Loading-unloading system with chuck up/down function		Option				
Square rotator		Option				
Fume collector		Option				

Software

Interactive cutting software (PIPE STUDIO)	Standard
PIPE STUDIO for PC	Standard
Nesting software	Standard
Data conversion software for AUTOCAD	Standard
Data conversion software for TEKLA	Option
Data conversion software for CSV	Option
SHS, RHS cutting software	Option
Foot print for welding software	Option
Cutting software for taper tube	Option
Cutting software for AWS/API	Standard

Touch and feel the future of piping!! Extremely simple and user-frendly!!

PIPE STUDIO

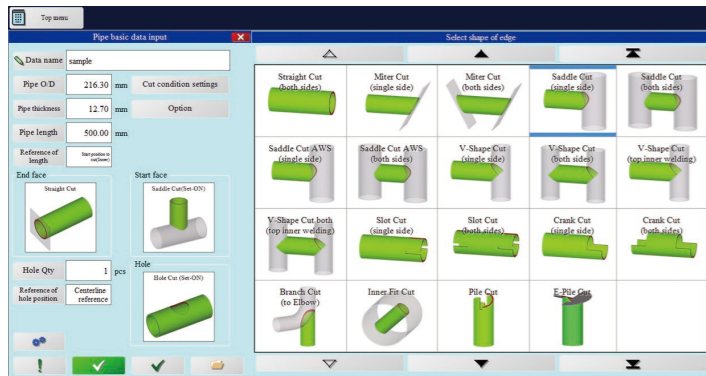

Select cutting shape

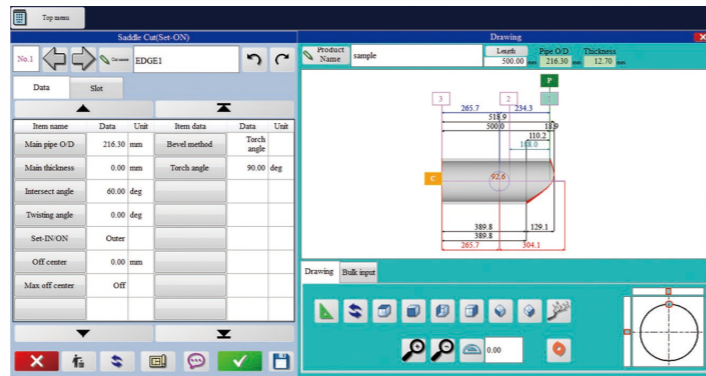

3D visualization view

NESTING

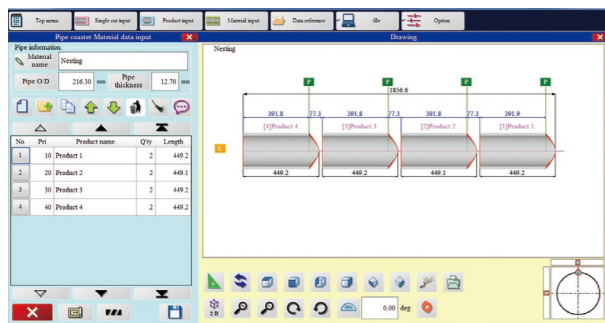

Before Nesting

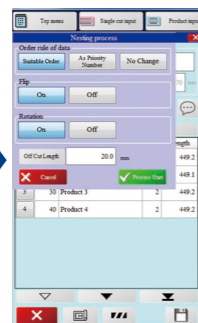

Nesting

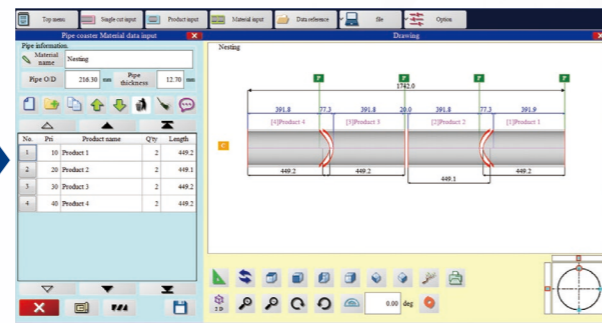

After Nesting

PIPE LABO

TEKLA STRUCTURES

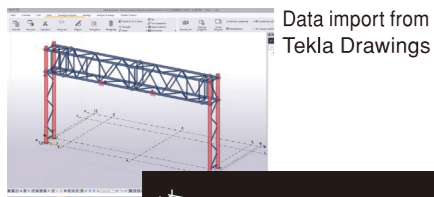

Data import from Tekla Drawings

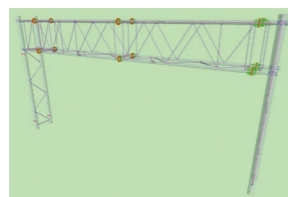

3D visualization check view

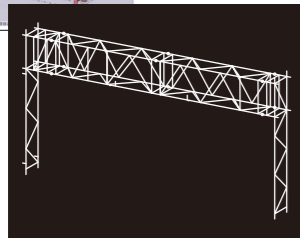

Imported drawing

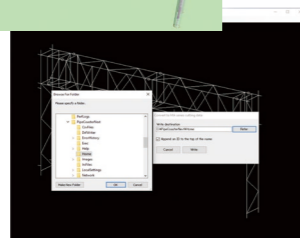

Save converted data

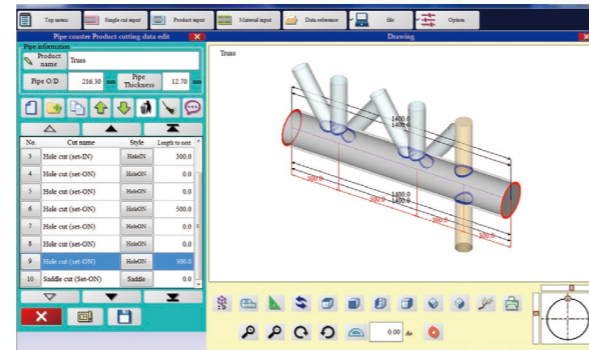

3D Product drawing

AUTO CAD(DXF)

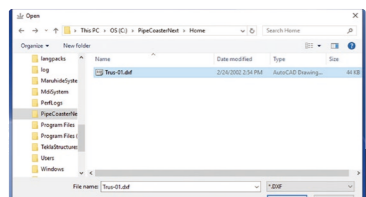

Data import from Dxf file

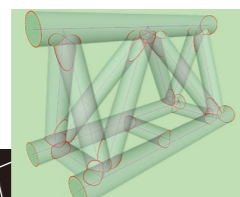

3D visualization check view

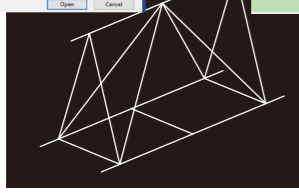

Imported drawing

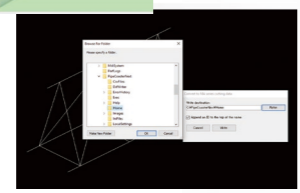

Save converted data

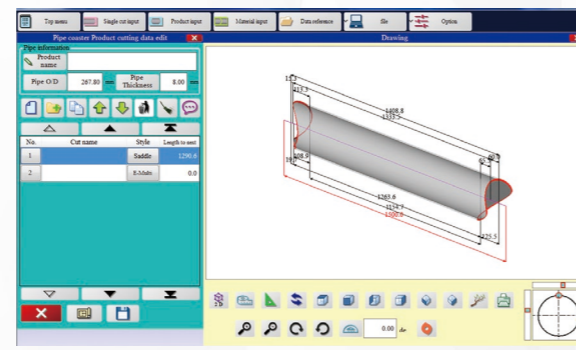

3D Product drawing

Production Control Software

Cutting time estimation

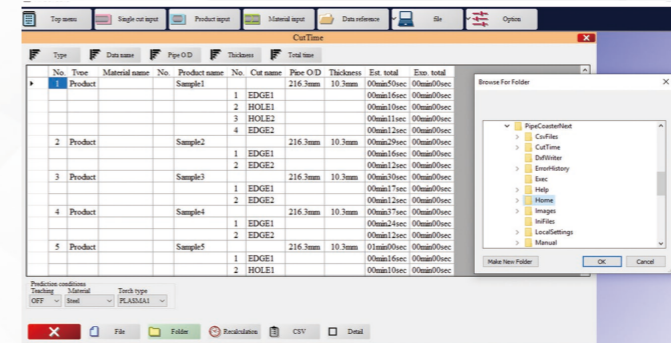

Job control

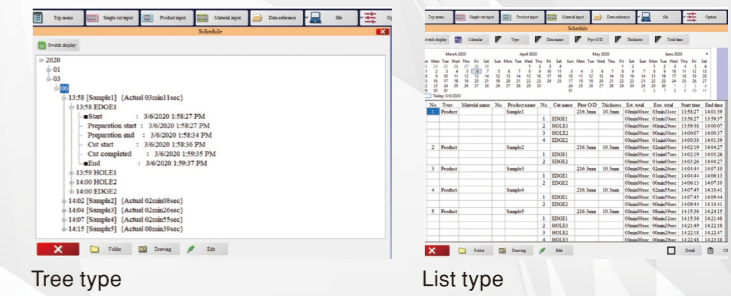

Tree type

List type

CSV Conversion Software

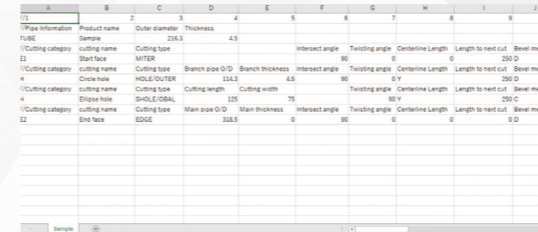

CSV file

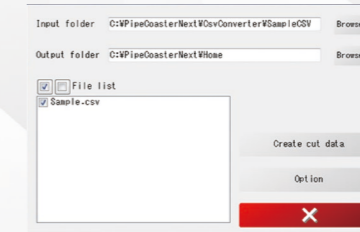

Conversion

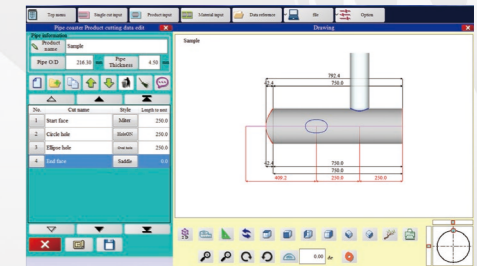

3D Product drawing

Dxf Template Cutting Software (dxf,png,bmp)

DXF Template Cutting

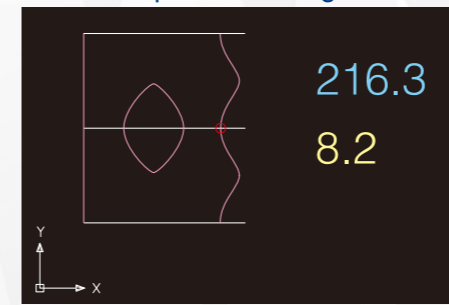

DXF file

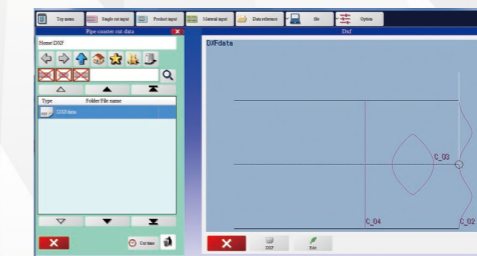

Edit and convert Dxf Template

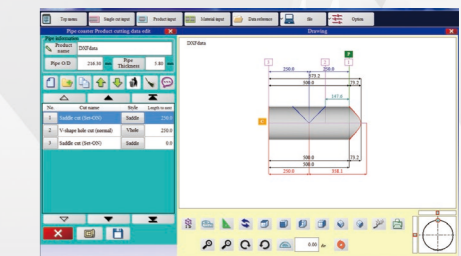

3D Product drawing

Image Picture Cutting Software



Image Picture

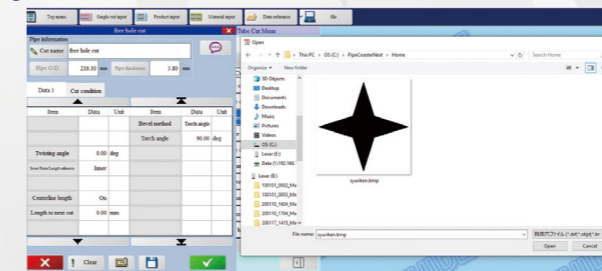

Edit and convert Dxf Template

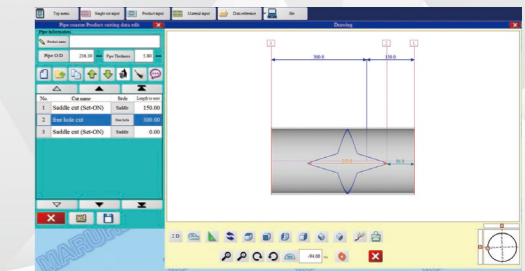

3D Product drawing

Export Cut-Template Software

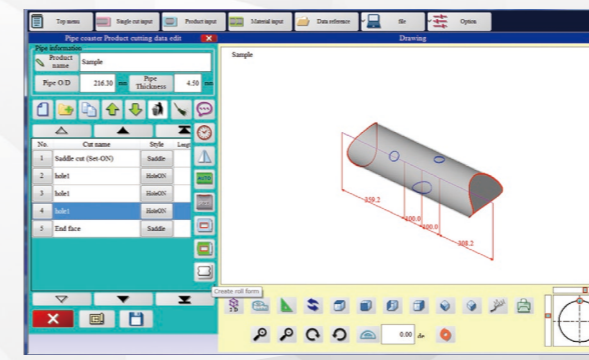

3D Product drawing+Export

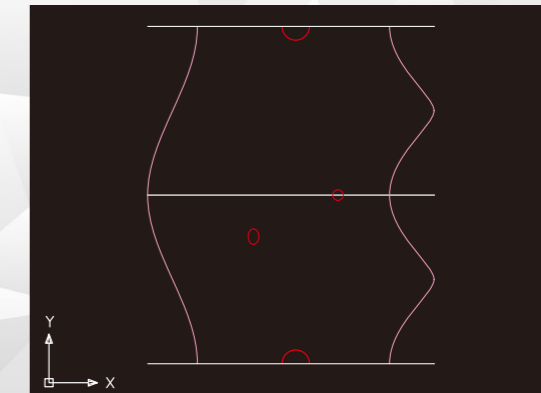

Exported Cut-Template (Dxf)

Shipbuilding

Demonstrates true performance in all kinds of cutting in piping for shipbuilding!



Saddle

Automatic calculation for weld preparation and nesting!



Completed product

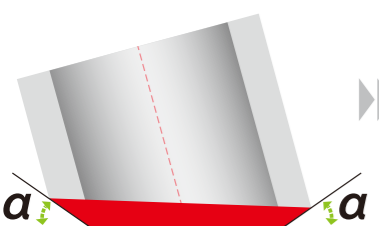

With weld preparation

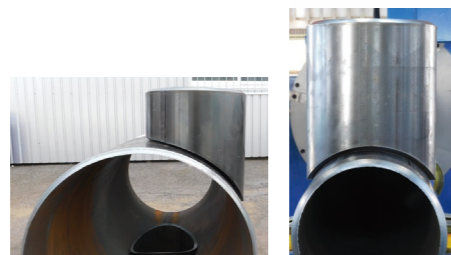

Off-center saddle

T-joint saddle

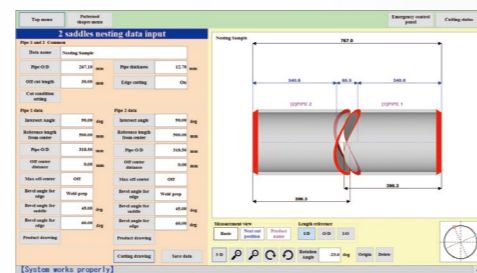

Nesting

Hole cut

Optional hole bevel angle

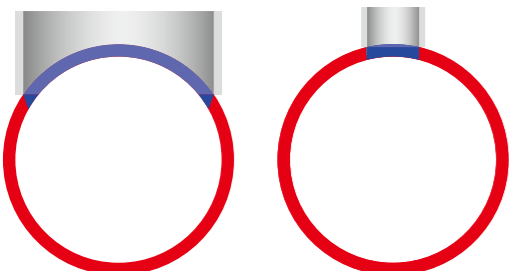

Combination for chuck rotation

Non-chuck rotation

Saddle to elbow

Various angles can be selected for elbow

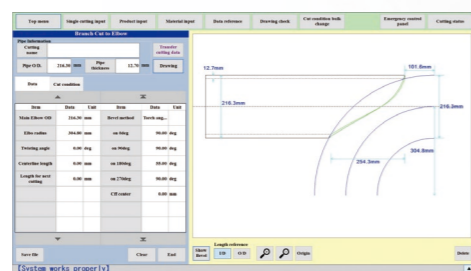

Completed product

General Piping

A wide range of general piping can be covered with one machine!!



e.g. Pressure vessels, tanks, water plants, prefabricating pipes and more!



Completed product

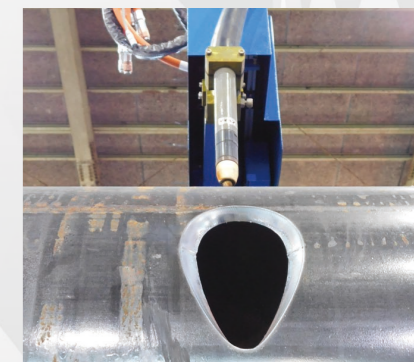

Tear drop hole with bevel

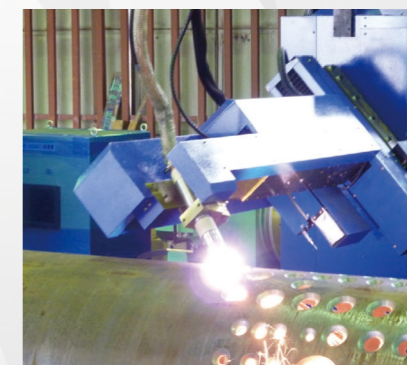

Cutting

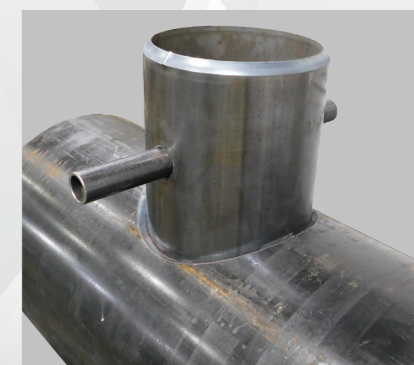

Hole with bevel

Patterned Shapes

Tailor entry data for industry-specific patterned cutting!

Processing flow for lobster tail

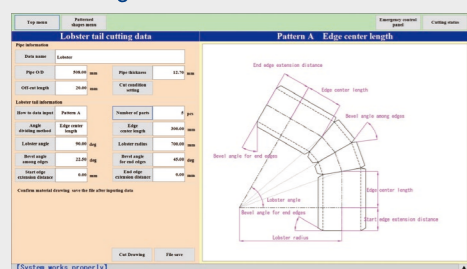

Input from drawing data

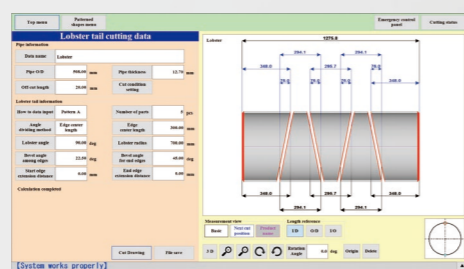

One step for cutting data & nesting



Completed lobster tail

Patterned Shapes

Processing flow for strainer

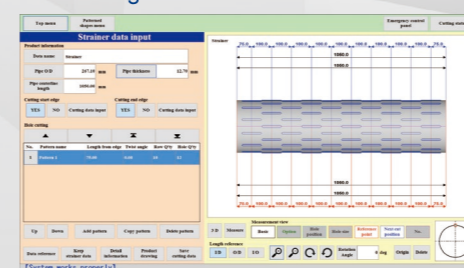

Input numbers and positions of hole
Only one-minute operation



Cutting

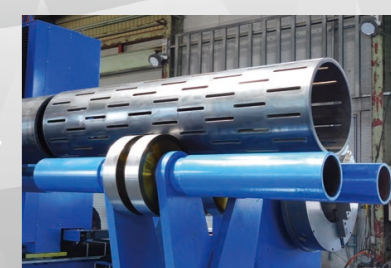

Completed product

Complex pipe structures (PIPE / SHS / RHS)
can be coordinated in one shot using 3D CAD conversion!!



Prime example

Performance demonstrated in piping for the roof of Bangkok International Airport (Suvarnabhumi Airport) consisting of **158,000 pipes** !

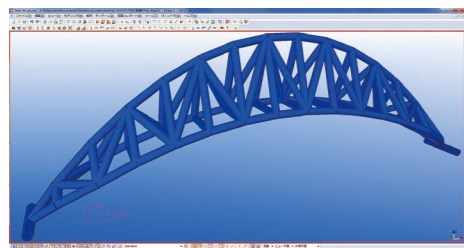

3D CAD/TEKLA CAD

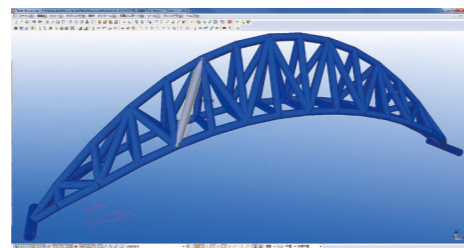

Bulk data conversion/TEKLA CAD

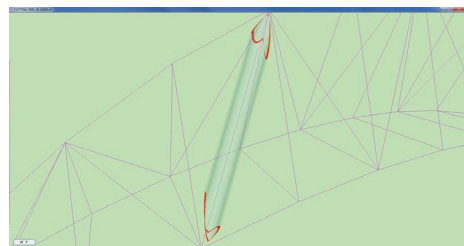

Data preparation complete/3D VIEW



Multiple joints

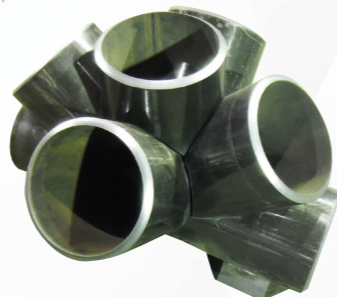

Multiple assemblies

Played a considerable role in expansion runway construction at Tokyo International Airport!!
AWS standards are fully covered!!



Reference lines were automatically marked off using an automatic marking system **Increased efficiency thanks to a dramatic reduction in marking times!**



Cutting piece AWS



Thickness 60mm with AWS



Cutting with AWS Intersecting angle of 37 degrees



Cutting piece with 4 reference line marking

Prime example

Played a major role in pipe cutting for Tokyo SKYTREE with the development of a new bevel method!



Mid-cutting



Post-cutting



TOKYO SKYTREE
Welding preparation
(Upper part)

TOKYO SKYTREE
Welding preparation
(Lower part)



Assembling



Welding



Special cutting shapes

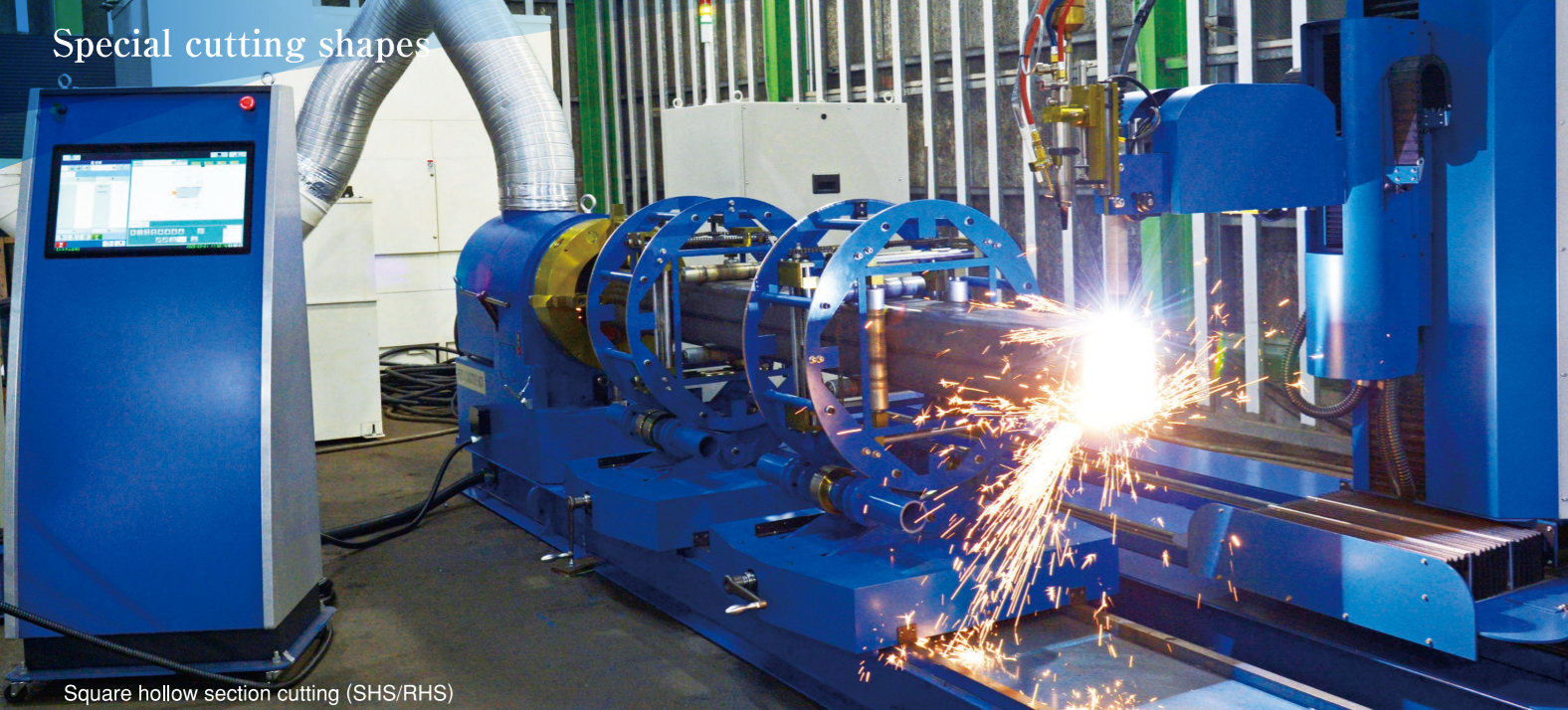

Square hollow section cutting (SHS/RHS)

Construction examples



Airport



H beam cutting



C channel cutting



Angle channel cutting



Flat plate cutting



Pipe Tower



Steel Structure Roof (Square Hollow Section)



Stadium

Examples of Cutting shapes

Any kinds of cutting can be arranged with reliable software by MARUHIDE. Please feel free to ask any concerns or questions regarding pipe cutting !

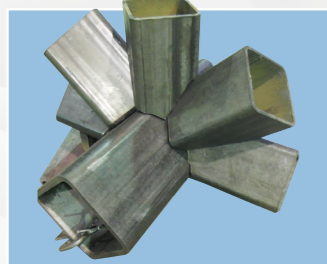

SHS multiple joint



Square hollow section cutting (SHS/RHS)



H beam cutting



C channel cutting

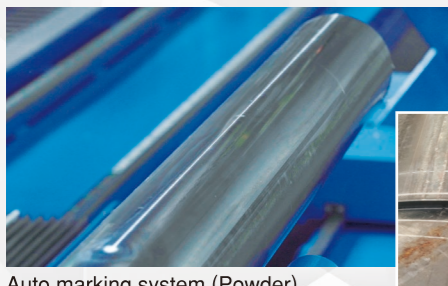

Auto marking system (Powder)



Angle channel cutting



Flat plate cutting